

Please go to www. quozel. com for product cleaning tips. Go to the **Care + Maintenance** selection.

Tools Required: Flathead screwdriver, Phillips screwdriver, pliers, wire cutters, wire strippers, electrical tape, safety glasses.

Light Source: (8) G9 Base Clear G9 Xenon Bulbs 40W Maximum (supplied).

Estimated Assembly Time: 20-30 minutes

Preparation: Identify and inspect all parts before beginning installation. Check package content list and diagrams below to be sure all parts are present. If any parts are missing or damaged, do not attempt to assemble, install, or operate the fixture. Contact customer service for replacement parts.

⚠ Warnings and Cautions

Turn off electricity at circuit breaker or main fuse box before installation. Consult a licensed electrician if in doubt.

These instructions are provided for your safety. It is very important you read them completely before installing the fixture. We strongly recommend that a licensed, professional electrician perform the installation.

Disconnect fixture from power source before replacing bulbs. Make sure bulbs are given sufficient time to cool before removal.

Do not touch the bulb with bare hands use a cloth or glove.

Package Contents

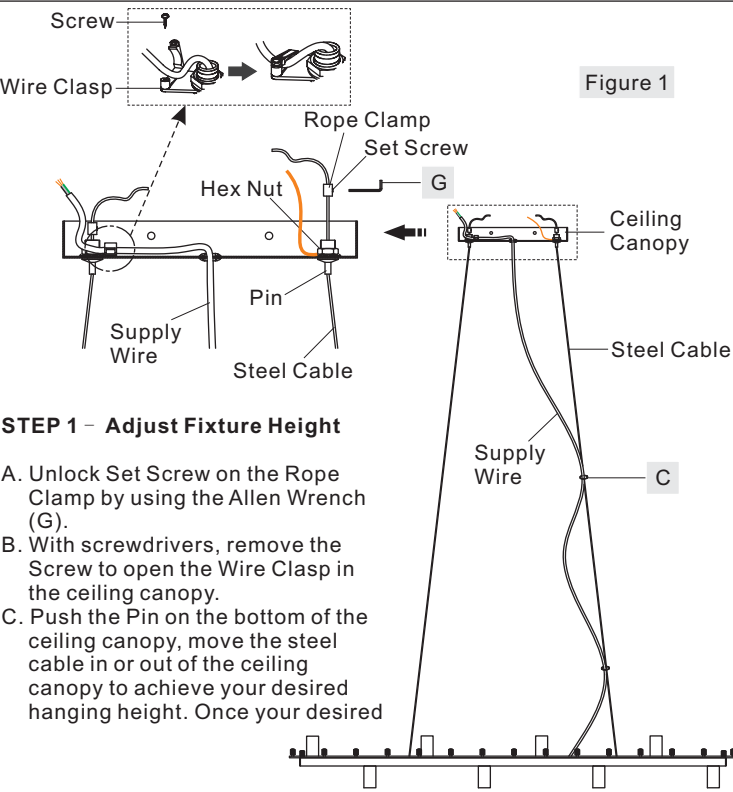
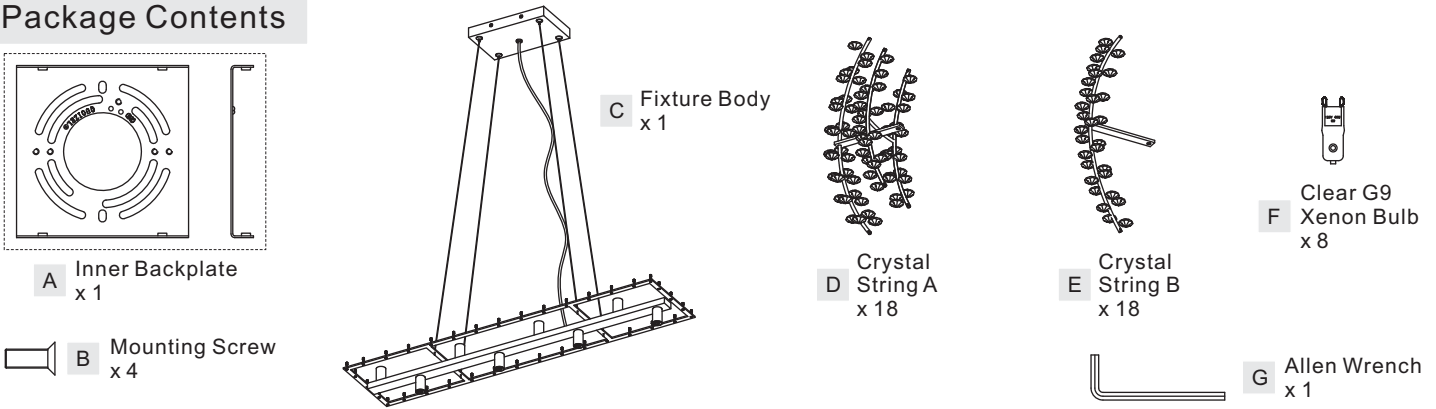

STEP 1 – Adjust Fixture Height

- A. Unlock Set Screw on the Rope Clamp by using the Allen Wrench (G).
- B. With screwdrivers, remove the Screw to open the Wire Clasp in the ceiling canopy.
- C. Push the Pin on the bottom of the ceiling canopy, move the steel cable in or out of the ceiling canopy to achieve your desired hanging height. Once your desired

(Step 1 Continued)

hanging height is achieved, move the rope clamp to hex nut inside of the ceiling canopy, and then tighten the set screw on the rope clamp with the Allen Wrench (G).
D. Insert slack supply wire into the ceiling canopy. Attach the supply wire to the wire clasp in the ceiling canopy and secure with the screw previously removed. Tighten until snug with screwdrivers.

STEP 2 – Install Inner Backplate

A. Pass the supply wires with ground wire through Inner Backplate (A). Attach Inner Backplate (A) to Outlet Box with the head of Green Ground Screw facing you. Secure it with Outlet Box Screws (not included). Tighten until snug.

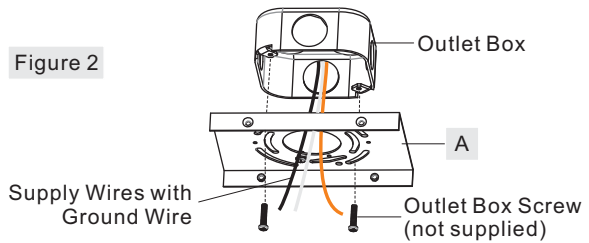

STEP 3 – Attach the Lanyard

A. The purpose of the lanyard is to provide a means to support the fixture hands free from the junction box while connecting the electrical wires.

Thank you for purchasing a Quoizel product.
Need assistance with parts or assembly? Call Quoizel customer service at 1-800-645-3184 or visit us on-line at www. quozel. com

(Step 3 Continued)

- B. Turn the Button Stop so it may be inserted into a Inner Backplate slot. Make sure the Button Stop is completely inside the Inner Backplate. Slowly release the fixture to make sure it is supported by the Button Stop. Proceed to the wiring steps in the next step. Once you are complete with the wiring, the Lanyard will push into the junction box when the fixture is placed for final mounting.

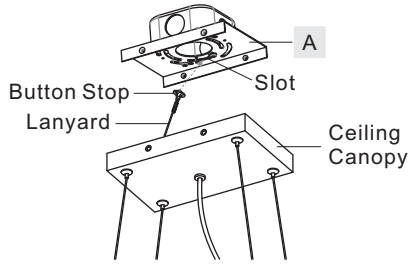

Figure 3

STEP 4 – Make Wire Connections

- A. Use standard wire connectors (not included) to make all wire connections. Twist connectors until wires are tightly joined together. Wrap each connection with approved electrical tape and carefully stuff all the connected wires into the Outlet Box.
- B. If the electrical wire is going to be cut shorter than provided, strip back the clear wire covering the 3 fixture wires as far as you need to. This will expose each fixture wire individually. Strip each end of 3 fixture wires.

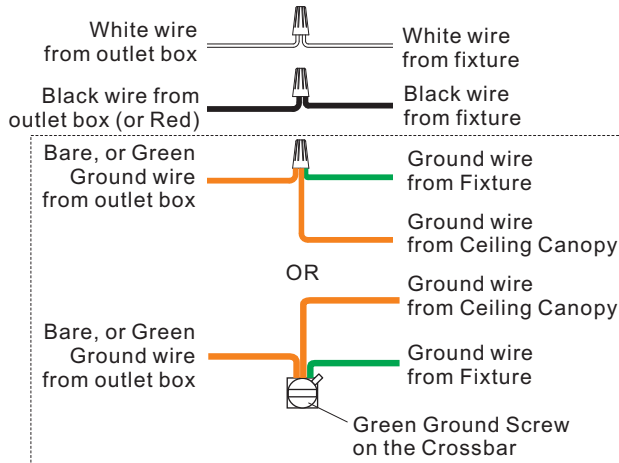

Figure 4

STEP 5 – Install the Fixture Body

- A. Position the ceiling canopy and Fixture Body (C) onto the Inner Backplate (A) and secure with Mounting Screws (B). Tighten until snug with screwdrivers.

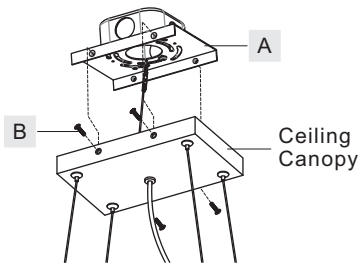

Figure 5

STEP 6 – Install Crystal Strings and Bulbs

- A. Remove Lock Balls from the Fixture Body (C).
- B. (Refer to CRYSTAL STRINGS DISTRIBUTION) Attach Crystal Strings A (D) and Crystal Strings B (E) to the bolts on the Fixture Body (C) one next to another and secure with previously removed Lock Ball. Hand tighten until snug.
- C. Insert bulbs (F) into sockets and push snugly into place.

IMPORTANT: Do not touch the bulb with bare hands use a cloth or glove.

Your fixture is now assembled and ready to use. Enjoy!

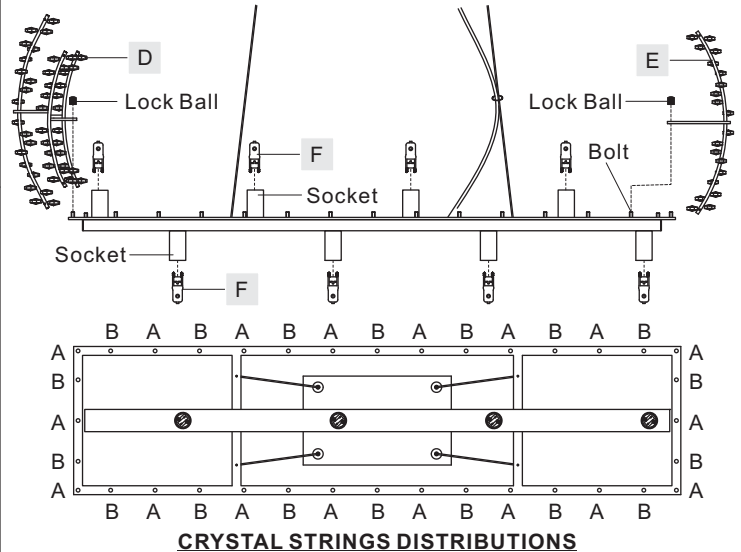

Figure 6

CAUTION FOR BULB REPLACING

- A. When replace bulb, turn off power and allow lamp to cool. For safety purpose, wear gloves and eye protection.
- B. If bulb is scratched or cracked, DO NOT use the lamp to avoid breakage during use or installation.
- C. Use only in fixtures rated for lamps wattage and voltage.
- D. Prevent the bulb from contacting liquid or combustible materials.

Thank you for purchasing a Quoizel product.
Need assistance with parts or assembly? Call Quoizel customer service at 1-800-645-3184
or visit us on-line at www.quoise.com

VLA839C

FINISH: POLISHED CHROME

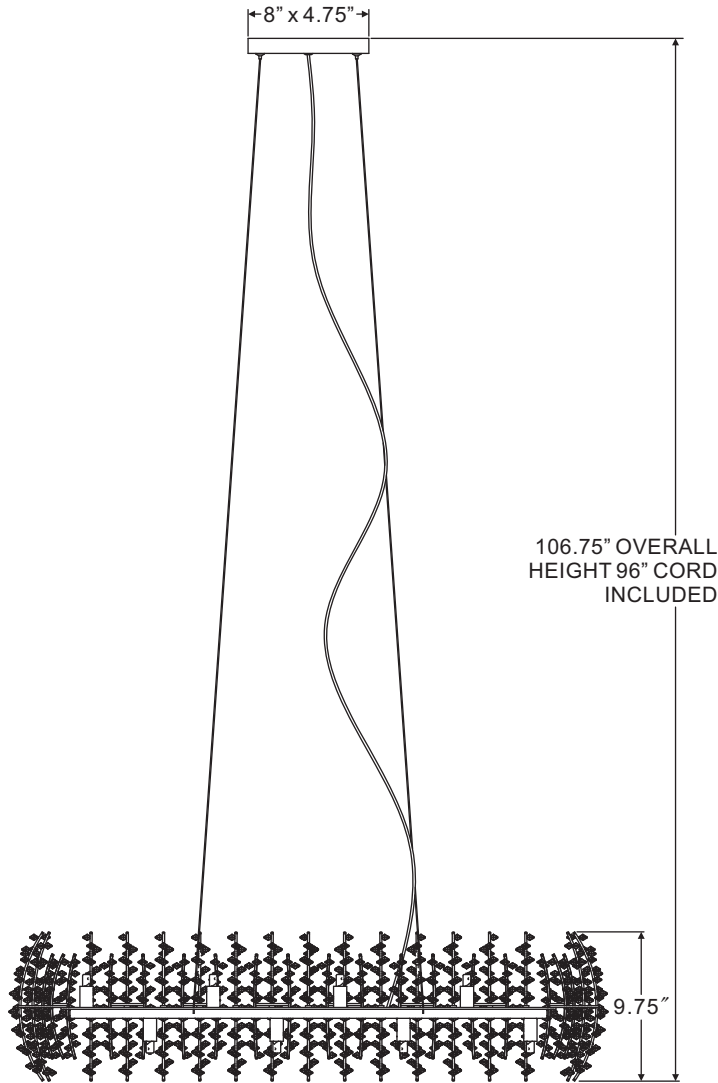
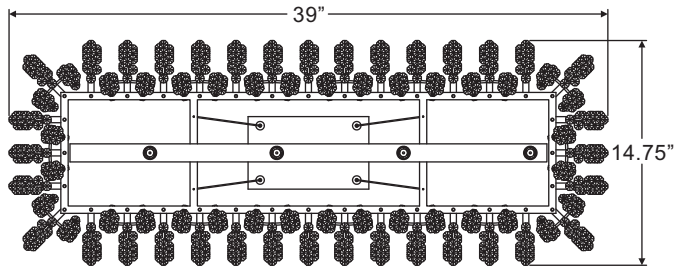
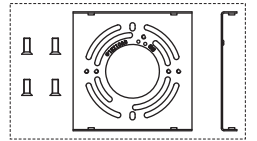

NOTE: ALL DIMENSIONS ARE ROUNDED UP TO THE NEAREST 1/4"

Thank you for purchasing a Quoizel product.
Need assistance with parts or assembly? Call Quoizel customer service at 1-800-645-3184
or visit us on-line at www.quoizel.com