

**Tools Required**

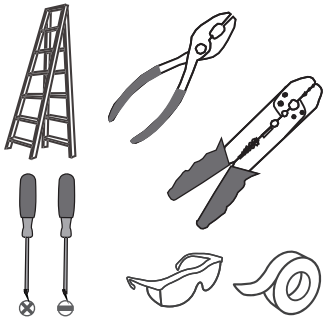

**Light Source**

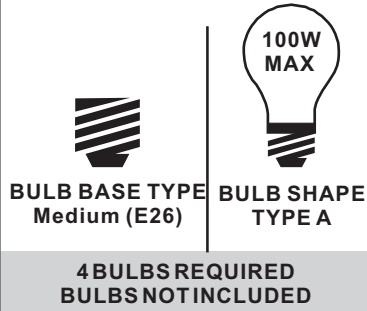

**Warnings and Cautions**

Turn off the electricity at the circuit breaker before installation. Consult a licensed electrician if in doubt about installation.

Turn off power to the fixture and allow the bulbs to cool before replacing.

**Package Contents**

**Preparation:** Identify and inspect all parts before beginning the installation.

Missing or damaged parts? Contact your original place of purchase.

**PARTS BAG**

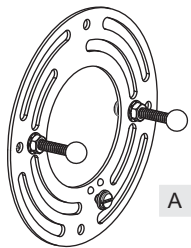

**A** Crossbar Assembly x 1



**B** Alternate Mounting Screw x 2



**C** Outlet Box Screw x 2



**D** Wire Connector x 3

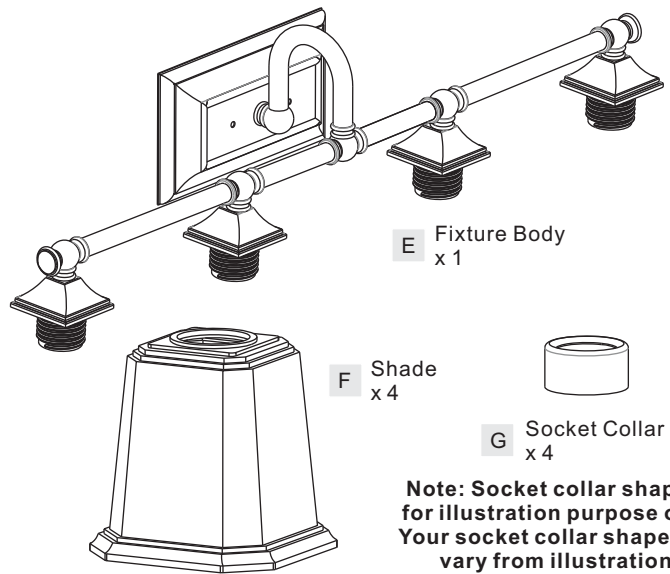

**E** Fixture Body x 1

**F** Shade x 4

**G** Socket Collar x 4

**Note: Socket collar shape is for illustration purpose only. Your socket collar shape may vary from illustration.**

**Table of Contents**

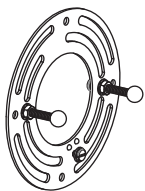
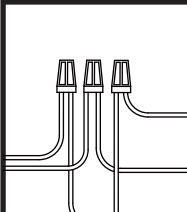
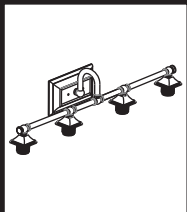
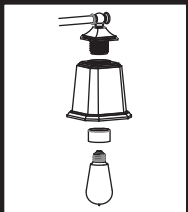
Alternate Mounting Screw	Crossbar Assembly	Wiring	Fixture Body	Shade & Bulb
				
<b>STEP 1</b>	<b>STEP 2</b>	<b>STEP 3</b>	<b>STEP 4</b>	<b>STEP 5</b>

# STEP 1

OPTION 1

Standard Mounting Screw



Included (Pre-assembled)

OPTION 2

Alternate Mounting Screw



Included

skip to next page

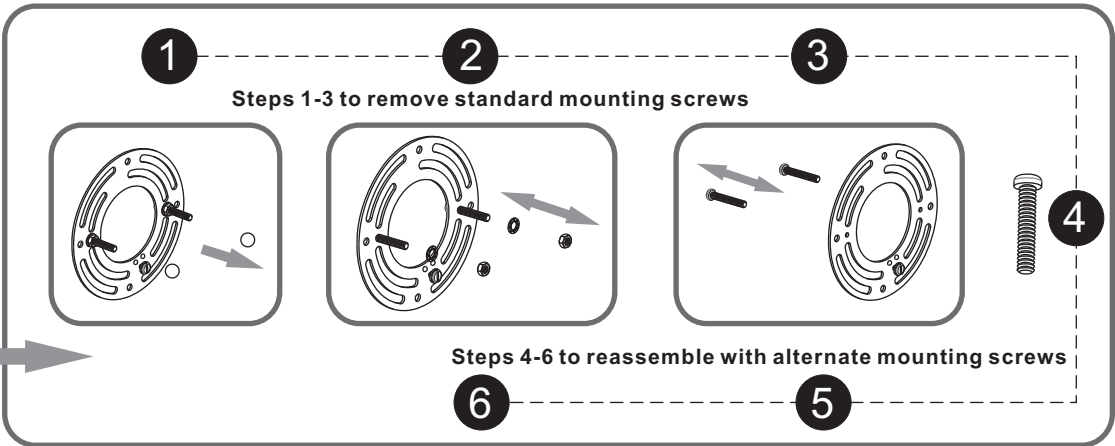

# STEP 2

1

Step 1  
Install crossbar assembly

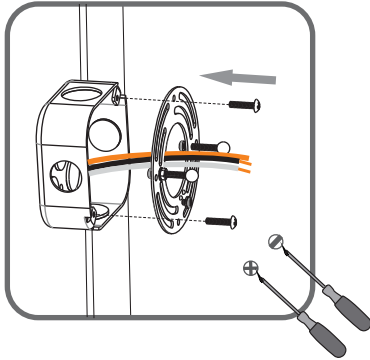

2

Step 2 - 3  
Test fitting backplate to mounting screws

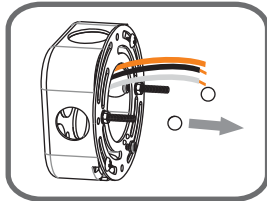

3

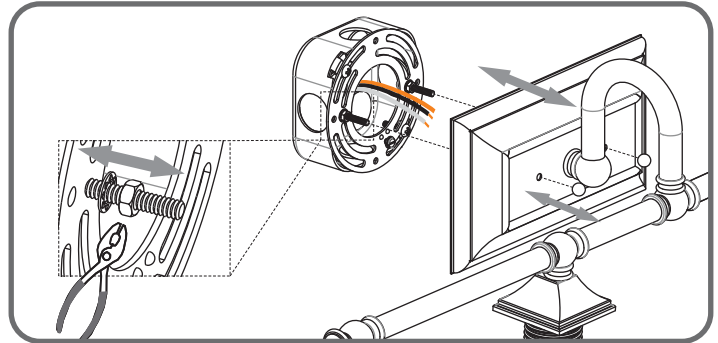

# STEP 3

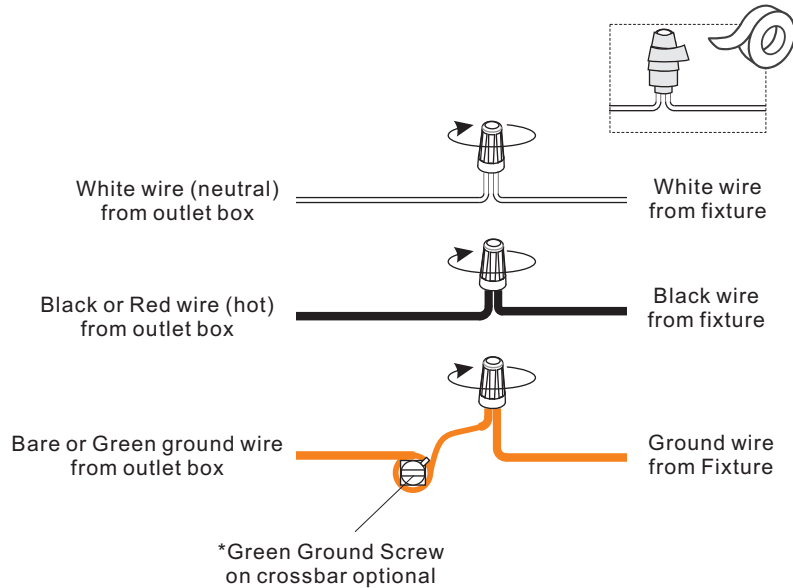

## STEP 4

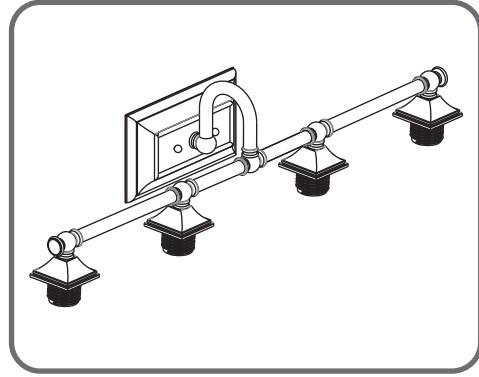
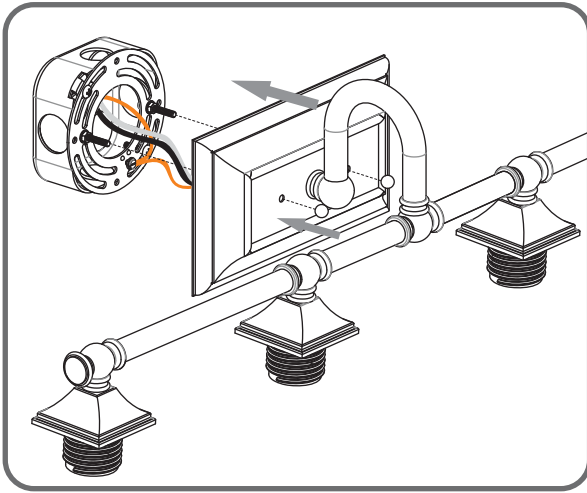

## STEP 5

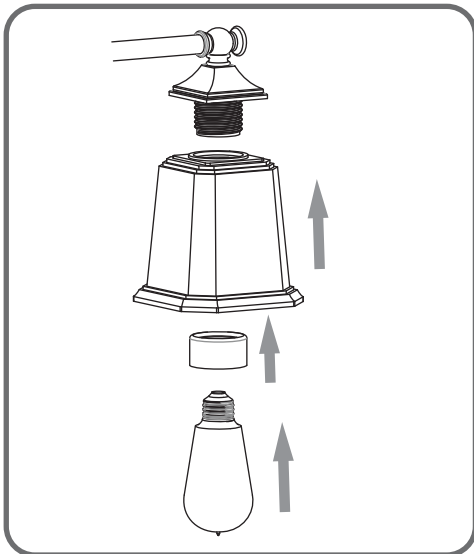

**Note: Socket collar shape is for illustration purpose only. Your socket collar shape may vary from illustration.**

