

Tools Required

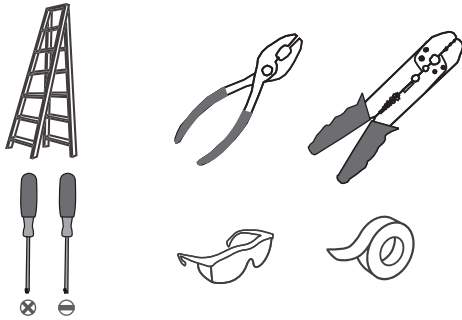

Light Source

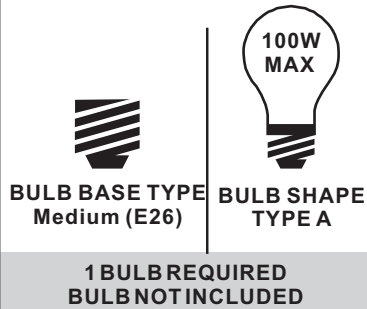

Fixture Height Adjustable
12.25" to 48.25"

Warnings and Cautions

Turn off the electricity at the circuit breaker before installation. Consult a licensed electrician if in doubt about installation.

Turn off power to the fixture and allow the bulbs to cool before replacing.

Package Contents

Preparation: Identify and inspect all parts before beginning the installation.

Missing or damaged parts? Contact your original place of purchase.

PARTS BAG

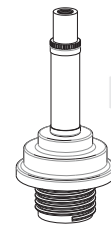
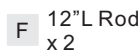
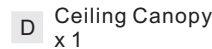
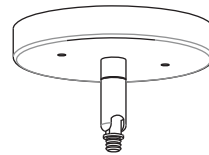
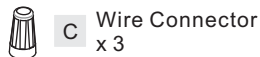
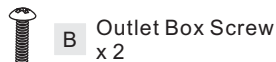
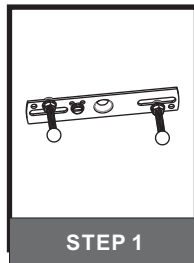
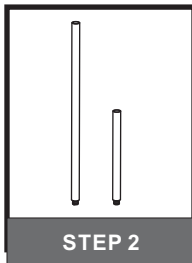

Table of Contents

Crossbar Assembly



Downrod



Wiring

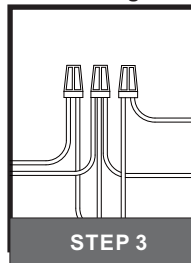

Ceiling Canopy

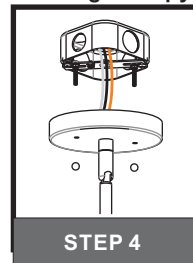

Shade & Bulb

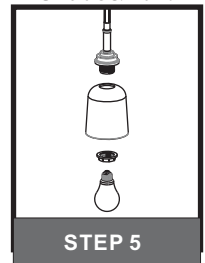

STEP 1

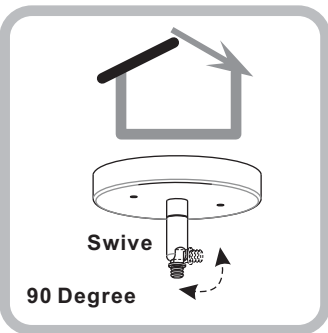

For angled ceilings, Swivel opening towards wall.

1

Step 1
Install crossbar assembly

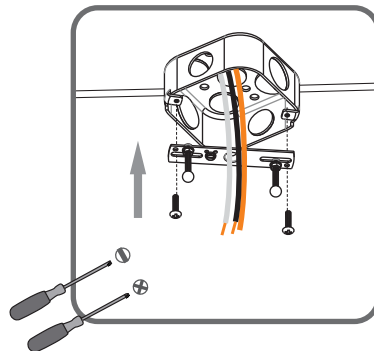

2

Step 2 - 3
Test fitting ceiling canopy to mounting screws

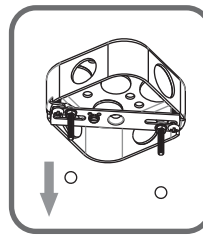

3

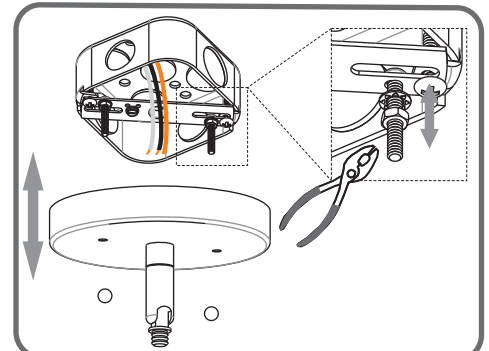

STEP 2

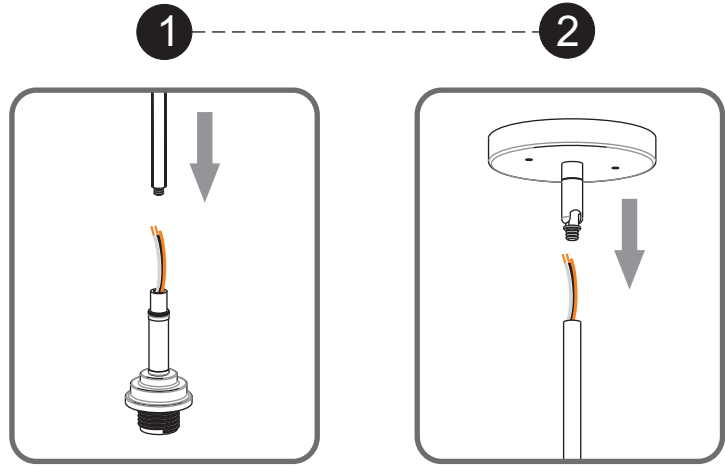
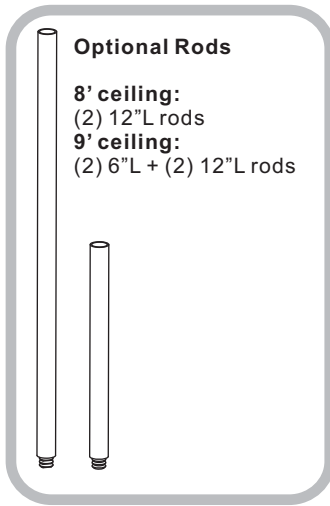

STEP 3

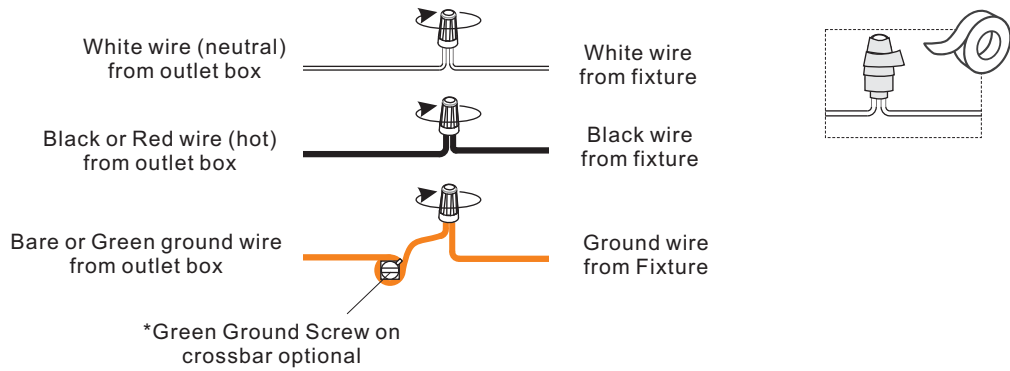

STEP 4

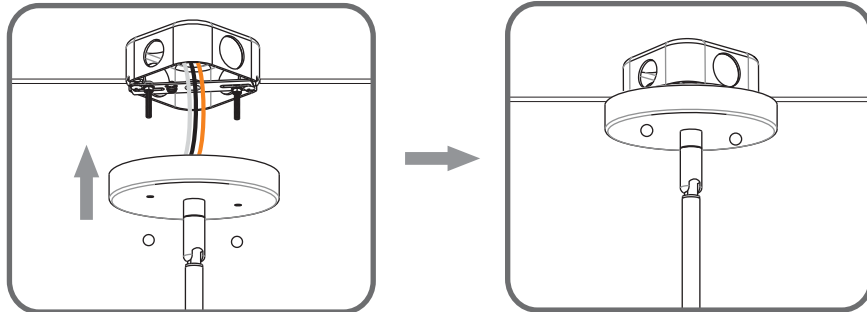

STEP 5

