

Tools Required

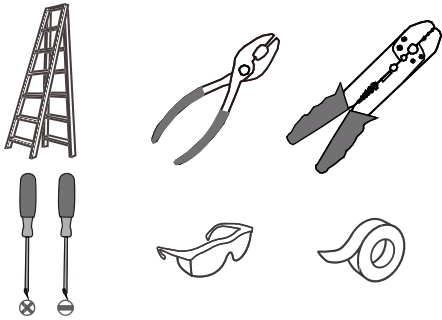

Light Source

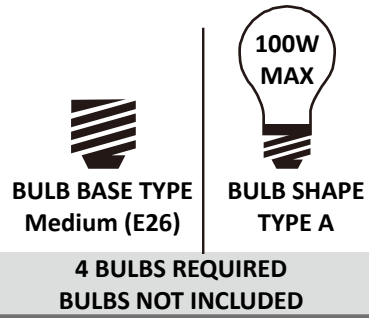

Warnings and Cautions

Turn off the electricity at the circuit breaker before installation. Consult a licensed electrician if in doubt about installation.

Turn off power to the fixture and allow the bulbs to cool before replacing.

Package Contents

Preparation: Identify and inspect all parts before beginning the installation.

Missing or damaged parts? Contact your original place of purchase.

PARTS BAG

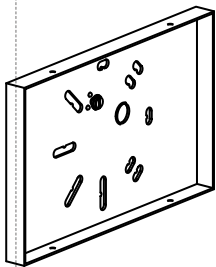

- A** Inner Backplate x 1
- B** Mounting Screw x 4
- C** Outlet Box Screw x 2
- D** Wire Connector x 3

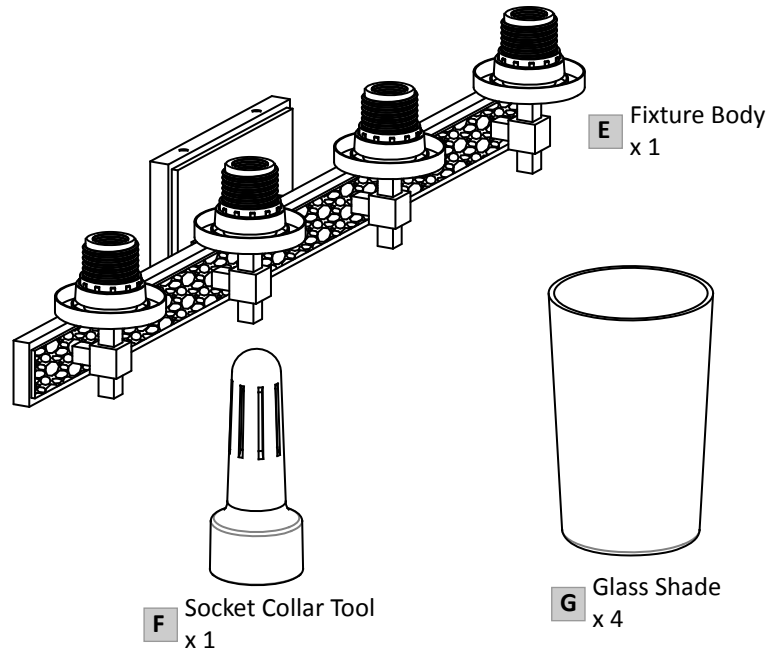
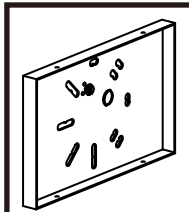

Table of Contents

Inner Backplate



STEP 1

Wiring

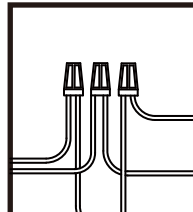

STEP 2

Fixture Body

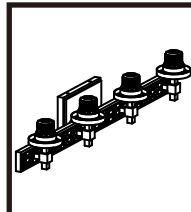

STEP 3

Glass Shade

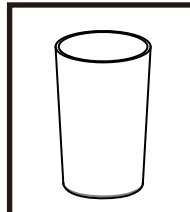

STEP 4

Bulb

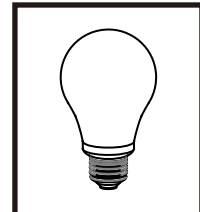

STEP 5

STEP 1

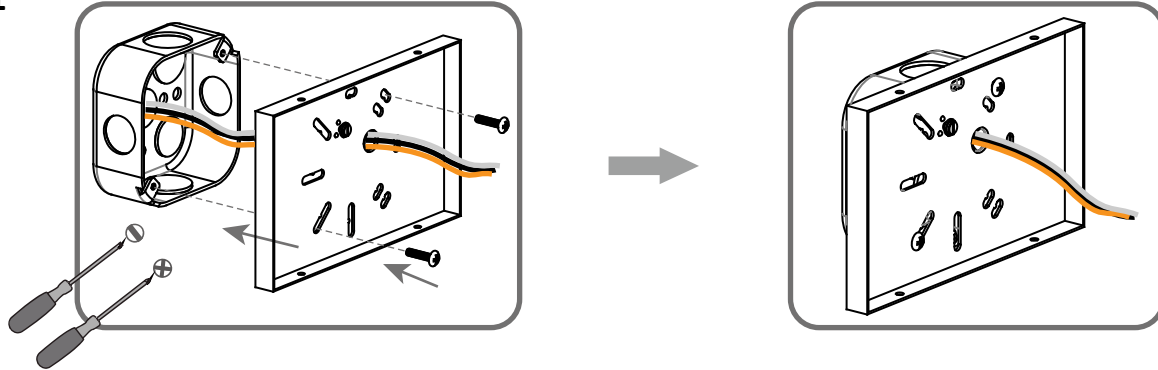

STEP 2

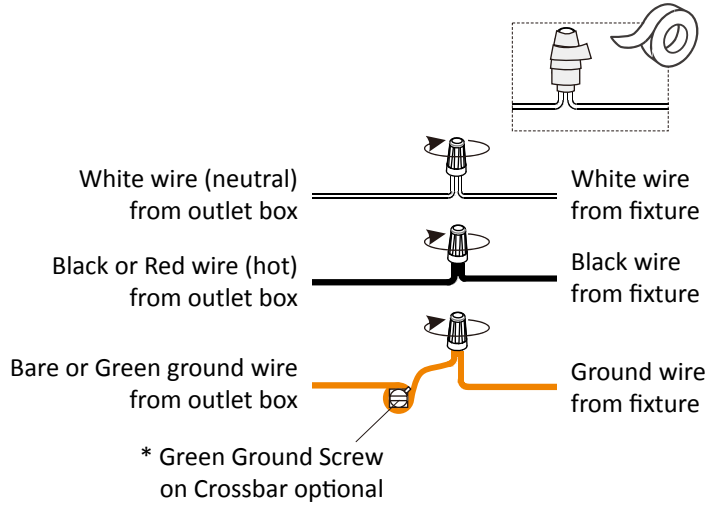

STEP 3

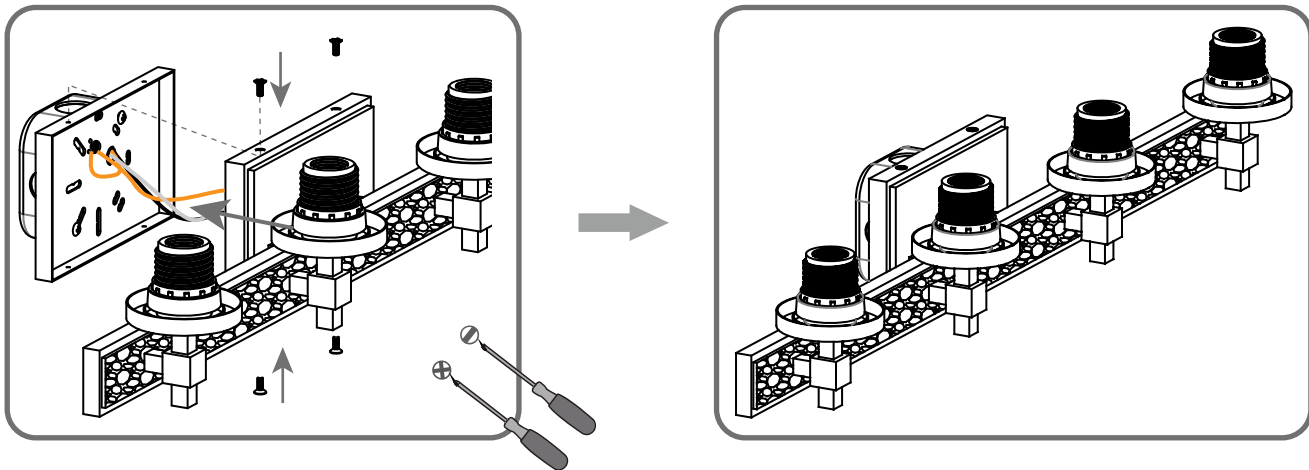

STEP 4

1

Remove socket collar

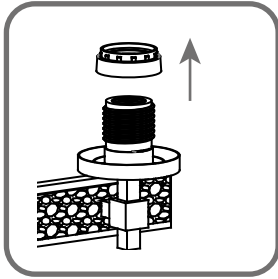

2

Install glass shade

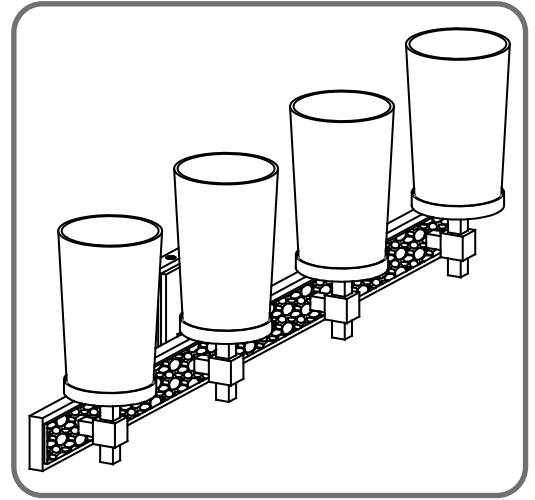
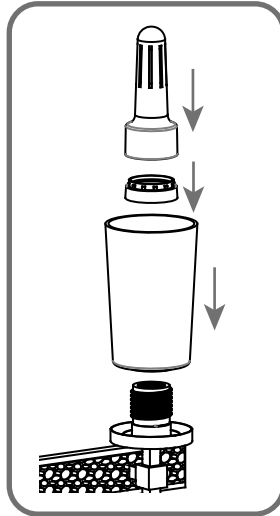

STEP 5

